

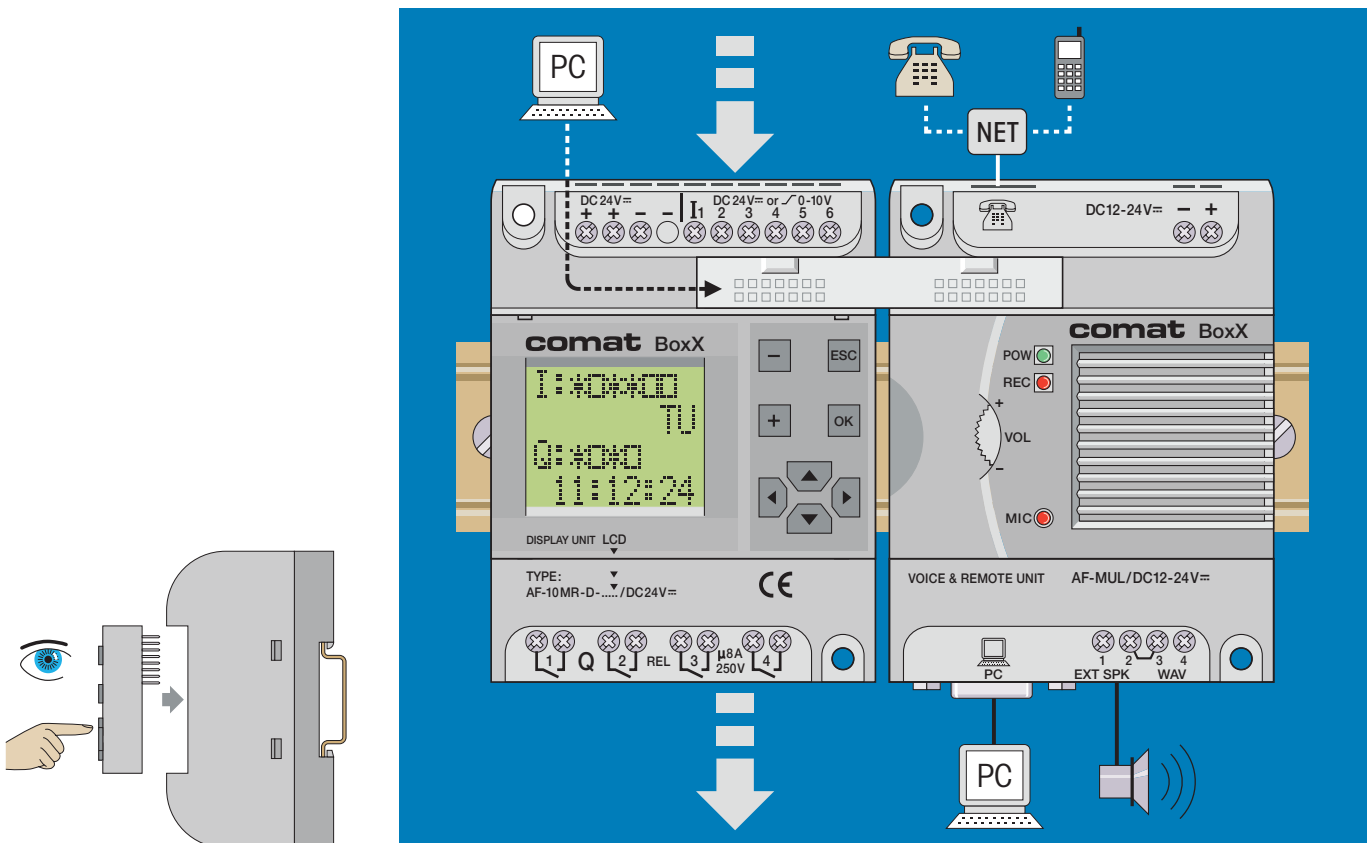

Automation Product

The speaking controller



SMS Relay / Comat BoxX

5

- Programming via PC
- Remote controlling and voice message over telephone network or Cellular phone
- Remote maintenance and remote operation of the installation
- Comprehensive function block library
- Password protected

The Controller

127

Function blocks
Intermediate relays
Timer instructions
(up to the year 2099)

- Program storage
- Time range
- Counting values
- System timer back up

64 kByte
0,01s-99,99h
1-999'999
100h

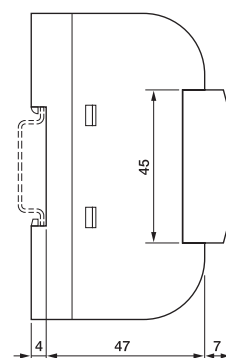
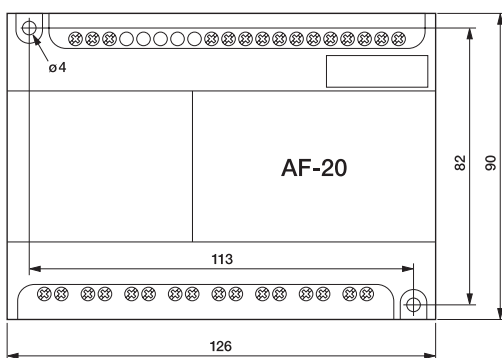
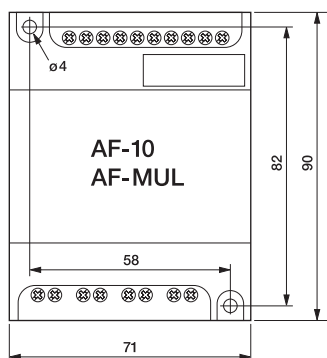
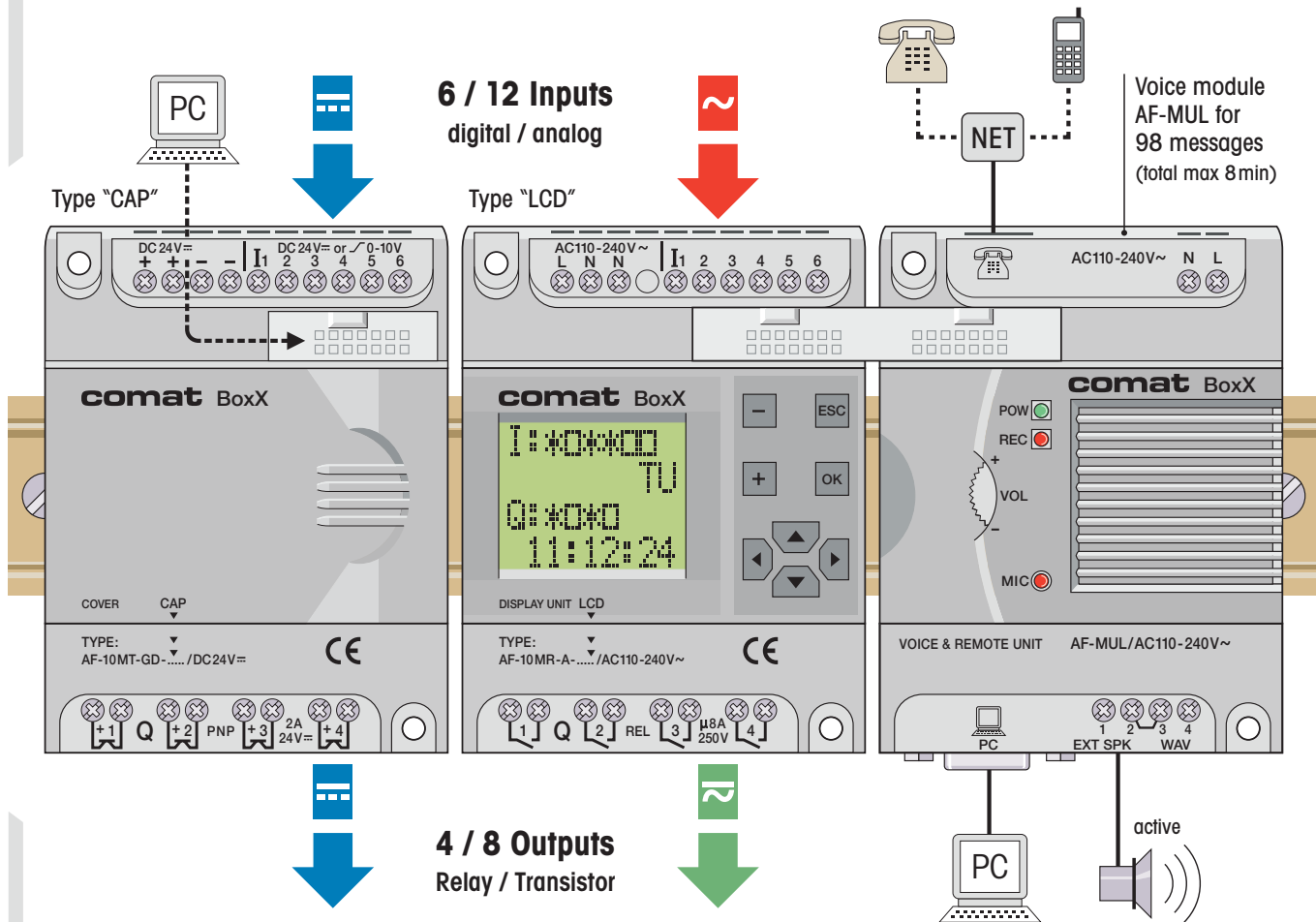

The Application

The Comat BoxX can be programmed by PC or with the snap-on LCD display with integrated function keys.

It is possible to modify time intervals of the function blocks in the existing control program on site directly on to the installation.

The LCD display can be connected to the Comat BoxX to visualize conditions or may be removed (without voltage) and used on another Comat BoxX.

The 24V versions of the Comat BoxX can also process analogue signals 0...10V with increments of 0.1V.

All inputs can be used or configured at random as analogue or digital inputs.

Function blocks for the comparison of analogue values are available, i.e. to monitor temperature in a heating system.

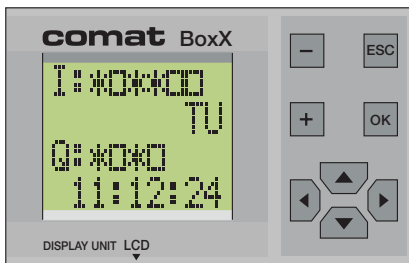

Setting the display

Analogue inputs

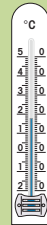

Programming software

The programming software QUICK II allows easy and transparent programming of the Comat BoxX with a PC.

QUICK II is based on Windows®. 127 function blocks can be stored inside the program memory of the Comat BoxX.

Stored programs cannot be lost even during a power loss. Therefore back up batteries are not needed.

With the simulation tool, the set up can be tested on the PC before commissioning.

Example: Page 4

Programming the function blocks

Control tasks can be solved easily with the function blocks available in the library.

Programming codes in a high-level program language are not required. Simply place the corresponding function blocks and link them with other function blocks according to the required control function.

The voice and remote module



The voice module allows the playing of messages through either the built-in or external loud speakers.

The voice module also replays phone calls or dials phone numbers to send emergency or status messages.

Messages are recorded directly over the built-in microphone or are transferred as *.wav files directly from the PC.

Programming software Quick II

Example: Programing environment

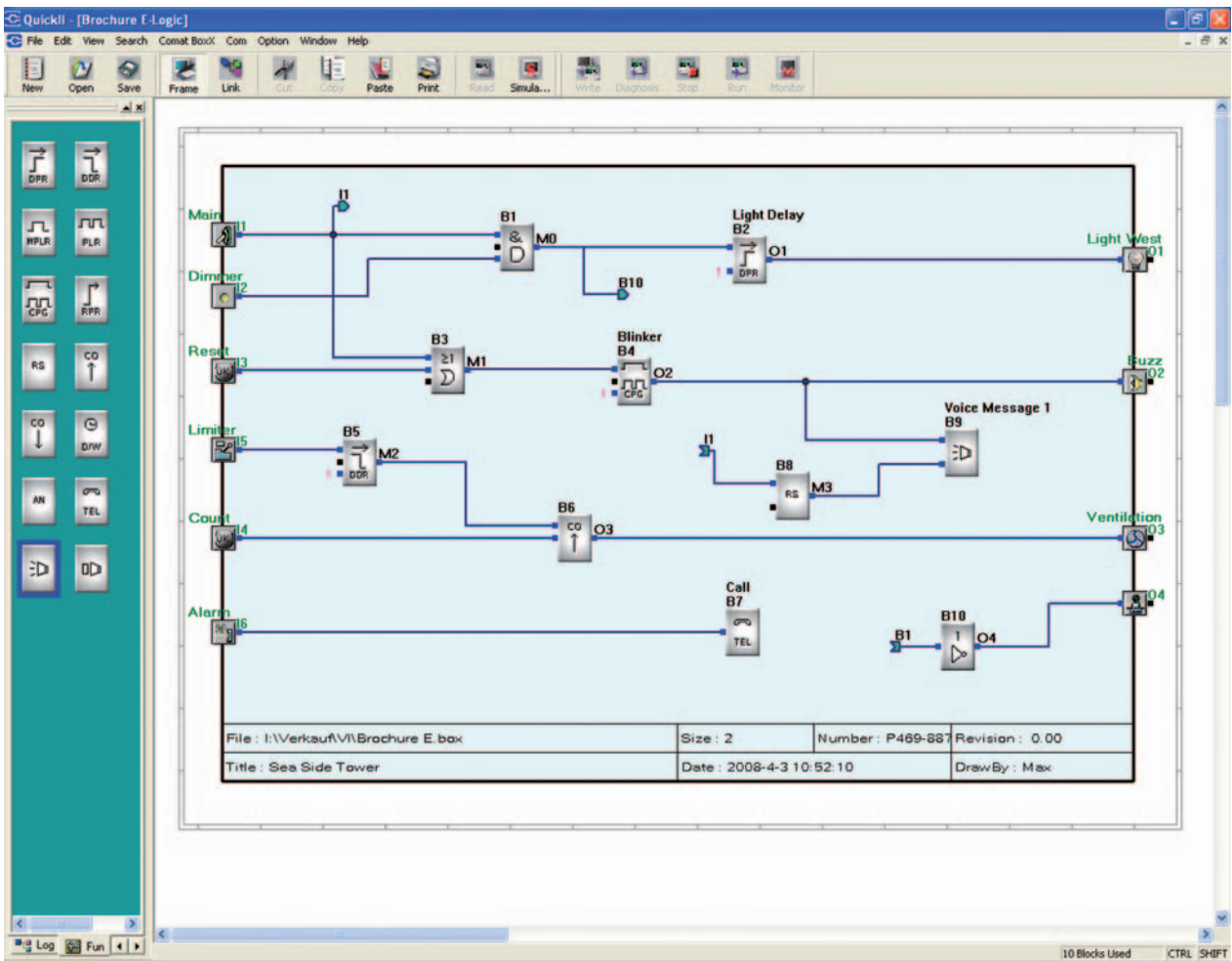

The Extension module



AF-D 232



Programming simulation and monitoring with the PC.

Programming via the MUL voice and remote unit

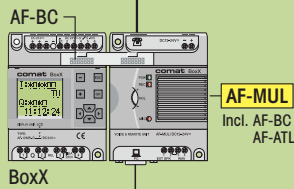
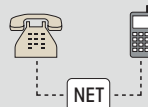

AF-RS 232



Each Comat BoxX can be controlled via a telephone line if connected to the extension module AF-MUL (voice & remote unit). The AF-MUL will answer calls and allows access after the password is accepted. The Comat BoxX with the AF-MUL is able to broadcast up to 98 pre-defined conditions, for example alarms, over the phone network. The designated phone number is dialled and the recorded message is played over the telephone. The message can also be broadcast over auxiliary loudspeakers.

Recording of messages with the PC

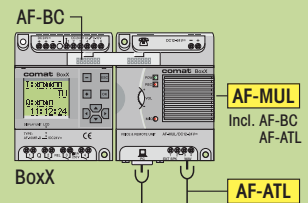

AF-RS 232

AF-AUD



Messages are transferred to the voice module as *.wav files directly from the PC over the AF-AUD cable.

The Types

U_B	6 INPUTS 4 OUTPUTS	U_B	12 INPUTS 8 OUTPUTS
6/12 Inputs digital AC110-240V	AC110-240V 50/60Hz INPUT L N N U_B I1 I2 6x I6 comat BoxX AF-10MR-A-...	AC110-240V 50/60Hz INPUT L N N U_B I1 I2 12x I12 comat BoxX AF-20MR-A-...	AC110-240V 50/60Hz INPUT L N N U_B I1 I2 12x I12 comat BoxX AF-20MR-A-...
4/8 Outputs relays 8A 250V~	RELAY μ 8A 250V Q1 Q2 4x Q4	RELAY μ 8A 250V Q1 Q2 8x Q8	RELAY μ 8A 250V Q1 Q2 8x Q8
Order no.	without display: AF-10MR-A-CAP/AC110-240V with display: AF-10MR-A-LCD/AC110-240V	without display: AF-20MR-A-CAP/AC110-240V with display: AF-20MR-A-LCD/AC110-240V	without display: AF-20MR-A-CAP/AC110-240V with display: AF-20MR-A-LCD/AC110-240V

	6/12 Inputs configurable: digital / analog 0-10V (0,1V)		
	4/8 Outputs relays 8A 250V~		
6/12 Inputs configurable: digital / analog 0-10V (0,1V)	DC24V= INPUT + + - - I1 I2 6x I6 comat BoxX AF-10MR-D-...	DC24V= or 0-10V INPUT + + - - I1 I2 12x I12 comat BoxX AF-20MR-D-...	DC24V= INPUT + + - - I1 I2 12x I12 comat BoxX AF-20MR-D-...
4/8 Outputs relays 8A 250V~	RELAY μ 8A 250V Q1 Q2 4x Q4	RELAY μ 8A 250V Q1 Q2 8x Q8	RELAY μ 8A 250V Q1 Q2 8x Q8
Order no.	without display: AF-10MR-D-CAP/DC24V with display: AF-10MR-D-LCD/DC24V	without display: AF-20MR-D-CAP/DC24V with display: AF-20MR-D-LCD/DC24V	without display: AF-20MR-D-CAP/DC24V with display: AF-20MR-D-LCD/DC24V
4/8 Transistor outputs PNP 2A 24V=	PNP 2A 24V= Q1 Q2 4x Q4	PNP 2A 24V= Q1 Q2 8x Q8	PNP 2A 24V= Q1 Q2 8x Q8
Order no.	without display: AF-10MT-GD-CAP/DC24V with display: AF-10MT-GD-LCD/DC24V	without display: AF-20MT-GD-CAP/DC24V with display: AF-20MT-GD-LCD/DC24V	without display: AF-20MT-GD-CAP/DC24V with display: AF-20MT-GD-LCD/DC24V

Accessories	Order no. AF-MUL/AC110-240V Voice and remote unit ¹⁾ AF-MUL/DC12-24V Voice and remote unit ¹⁾ AF-RS232 AF-MUL Programming cable AF-BC AF-MUL Bridge connector ²⁾ AF-ATL AF-5MUL Audio Cable ²⁾ AF-AUD Audio Cable	Order no. AF-D232 Programming cable CMS-USB Converter USB-RS 232 AF-MOD Modem AF-M232 Modem Interface connector AF-LCD Display with function keys AF-CAP Cover (instead of AF-LCD) AF-CDR1 CD-ROM
	¹⁾ Inclusive AF-BC and AF-ATL ²⁾ Included with AF-MUL	

The Data

	AF-10	AF-20	AF-MUL
Operating voltage U_B	AC110-240V~ 50/60Hz	AC110-240V~	AC110-240V~
	DC24V= ∇ max.10%		DC12-24V=
Power consumption	3VA/1,5W	5VA/1,5W	0,8VA
Switching power	\sim 8A 250V~	\sim 2A 24V=	
Ambience conditions	T_u without display -25...+55°C	T_u with display 0...+55°C	Rel. humidity: 5...95% (non condensing) Protection IP20